

1 2 3 4 5

A

B

C

D

E

F

G

A

B

C

D

E

F

G

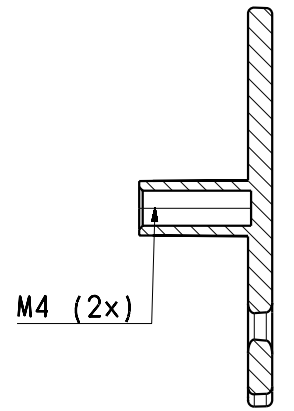
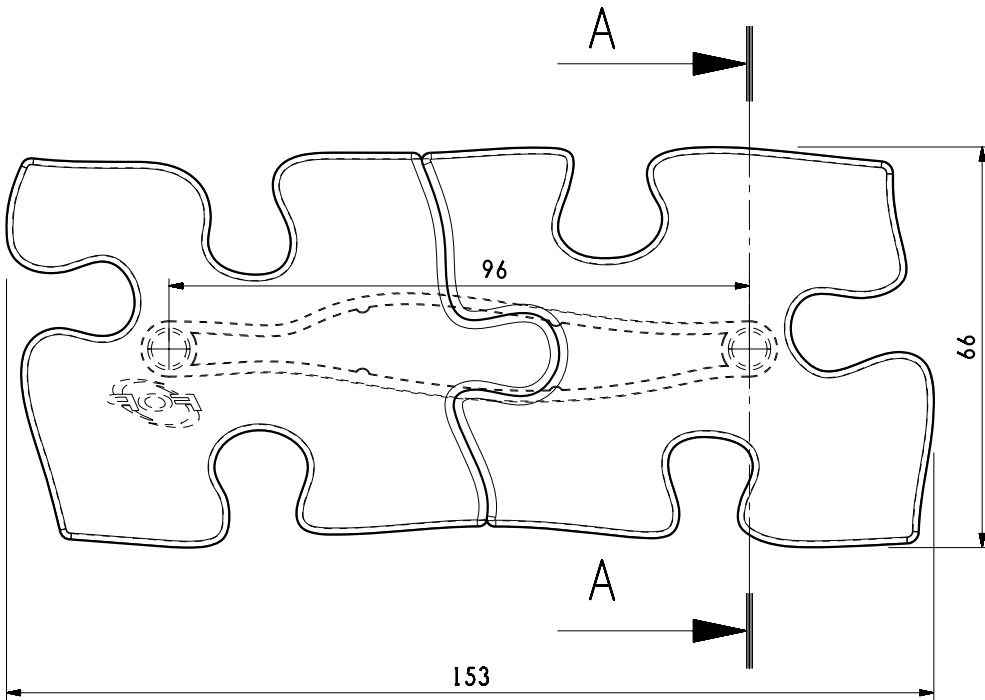
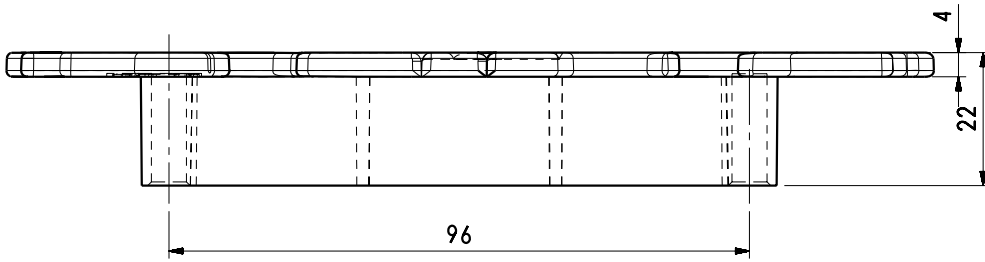
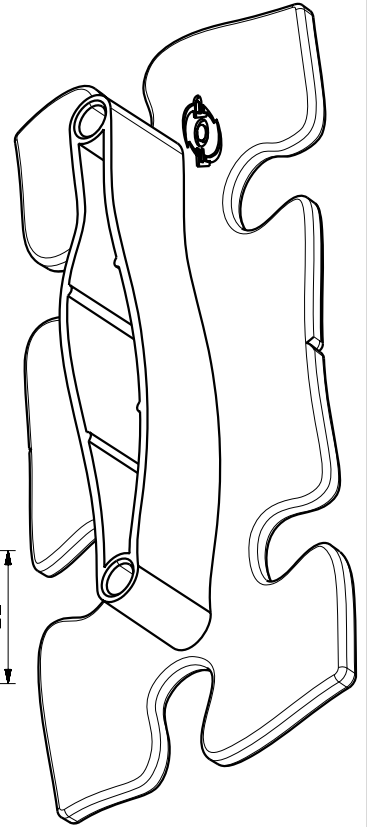
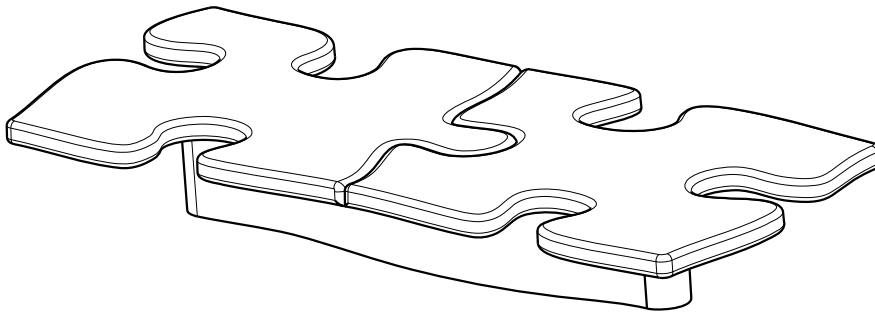



Sez. A-A

MATERIAL: ABS

REV	POSITION	DESCRIPTION	DATE	NAME



 	UNIT mm	TYPE DRAFT DRAWING	CREATED BY ****	FORMAT A4	REVISION ***
FILENAME ****	CLIENT ****		CREATION DATE ****	SCALE 1 : 1.25	SHEET 1 / 1
ART. 1027			PART CODE ****	TOOL CODE ****	
PROJECT NAME ****			CHECKED BY ****	CHECKED_DATE ****	****

1 2 3 4 5